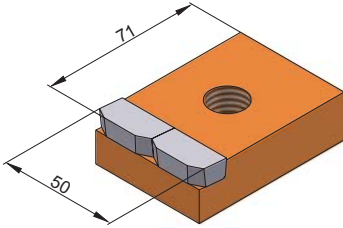
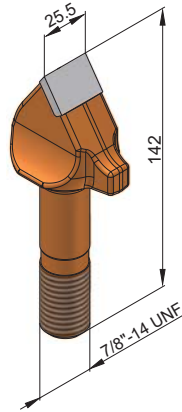

Bandit

→ **BFZ291**

→ BFS70x50x22

→ **BFZ195**

→ BFZ142x25-7/8"

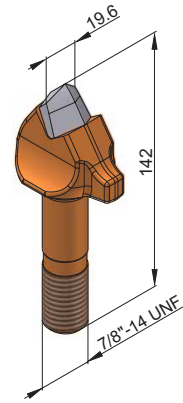
→ **BFZ212**

→ BFZ142x25-7/8"/5

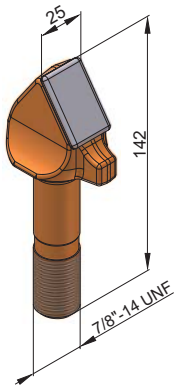
→ **BFZ223**

→ BFZ142x25/HS

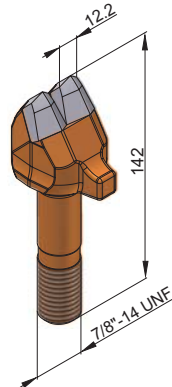
→ **BFZ232**

→ BFZ142x40-7/8"

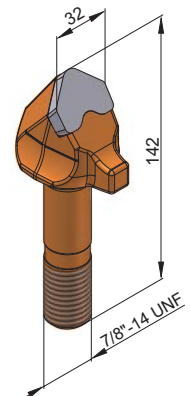
→ **BFZ262**

→ BFZ142x32-7/8"

Duratech

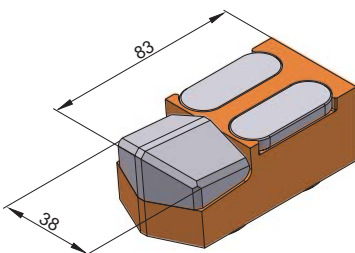
→ **BFS142**

→ BFS45x40x83/2

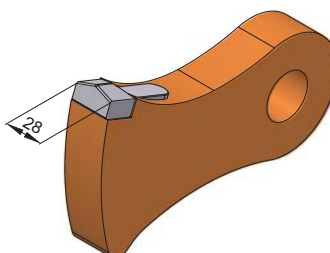
→ **BFS146**

→ BFS195x117x30/1

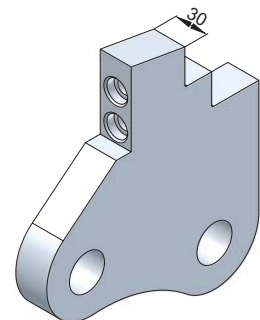
→ **BHS14**

→ BHS227x205x30

Duratech

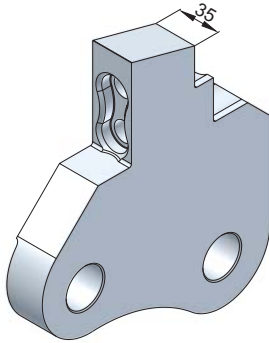

→ **BHS32**

→ BHS232x202x35

Jenz

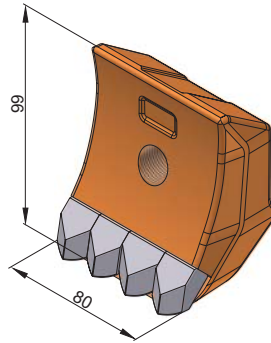

→ **BFS184**

→ BFS99x80/2



Morbark

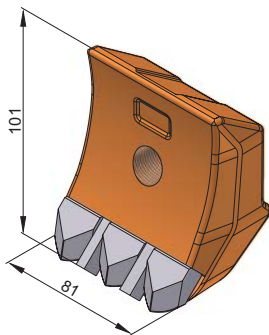

→ **BFS23/1**

→ BFS103x80/1

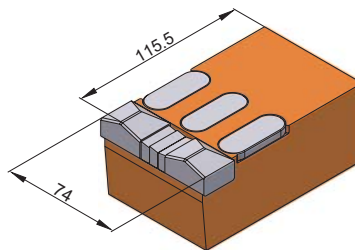

→ **BFS219**

→ BFS116x74x52/1

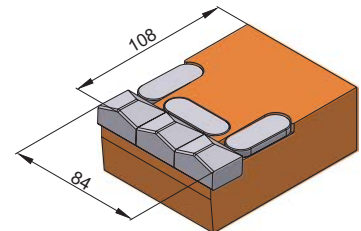

→ **BFS236**

→ BFS108x84x45



Morbark

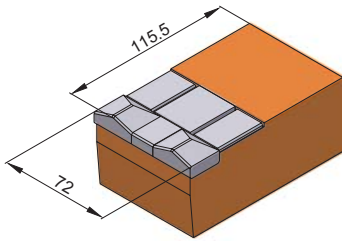

→ **BFS253**

→ BFS116x74x52/2

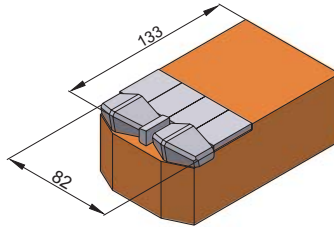

→ **BFS274**

→ BFS80x58x133/1

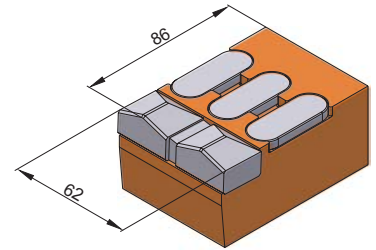

→ **BFS88**

→ BFS86x60/1

Plaisance

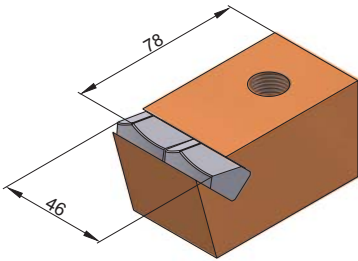

→ **BFS15**

→ BFS40x40/A/78

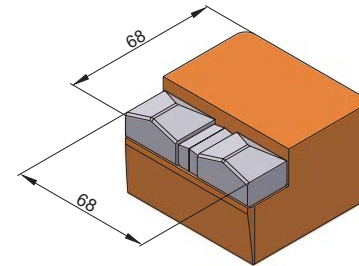

→ **BFS121**

→ BFS70x70x46/3

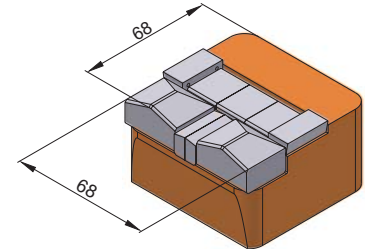

→ **BFS265**

→ BFS70x70x46/7

Seppi

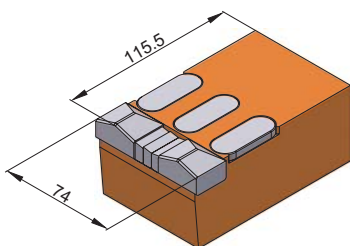

→ **BFS335**

→ BFS116x74x52/4

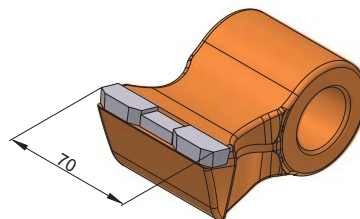

→ **BFS18**

→ BFS105x70x56

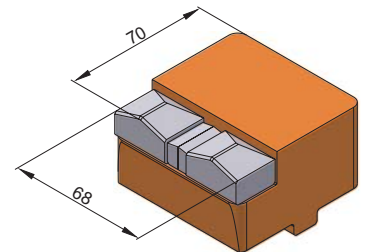

→ **BFS153**

→ BFS70x70x46/1

Vermeer

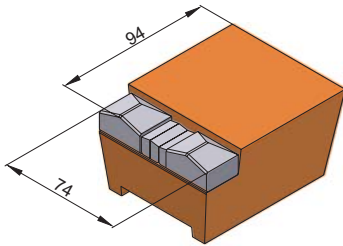

→ **BFS286**

→ BFS94x78x50

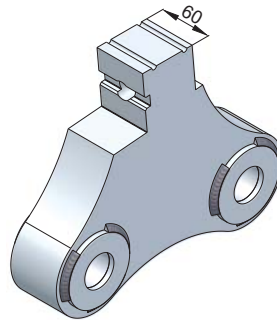

→ **BHS15**

→ BHS298x241x60

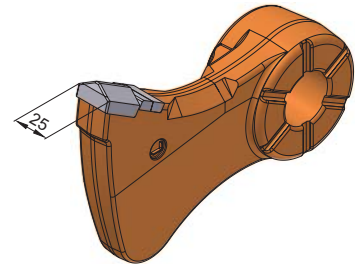

→ **BFS266**

→ BFS200x137x49/L/2

Weld-on teeth

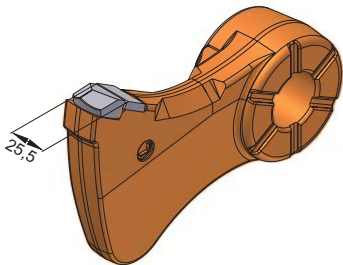

→ **BFS418**

→ BFS200x137x49/L/4

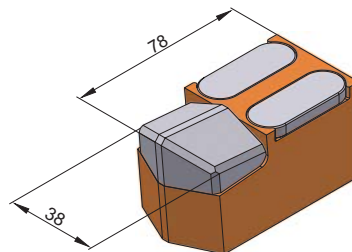

→ **BFS21**

→ BFS40x40x78/3

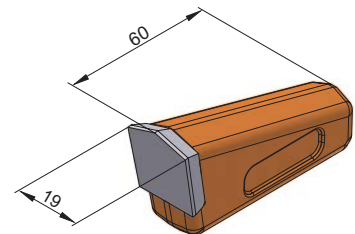

→ **BFZ133**

→ BFZ60x19/2

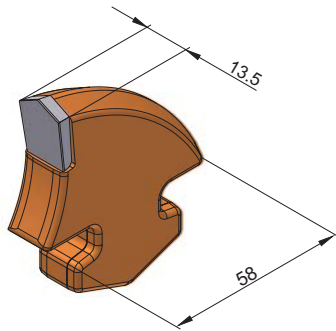

Rayco

→ **BFS304**

→ BFS65x58x14

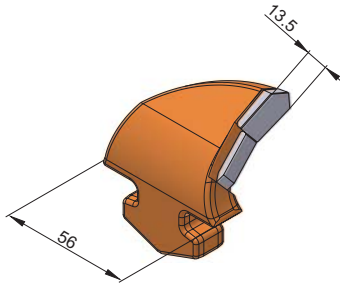
→ **BFS305**

→ BFS65x57x14/R

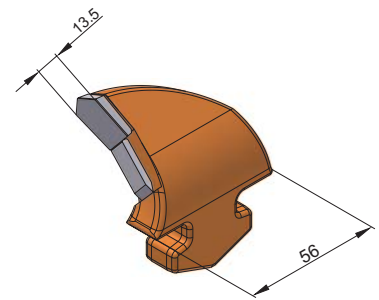
→ **BFS306**

→ BFS65x57x14/L

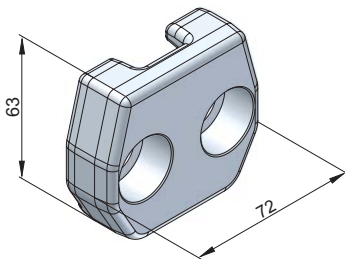
→ **BHS43**

→ BHS72x63x25/S

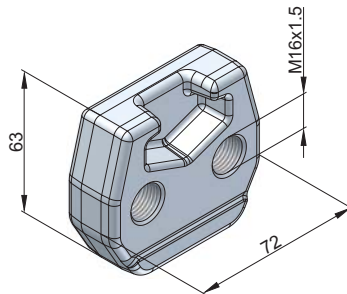
→ **BHS44**

→ BHS72x63x25/G

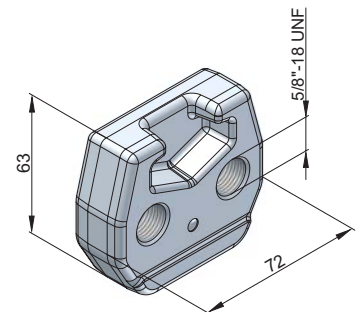
→ **BHS46**

→ BHS72x63x25/G/Z

Sandberger / Neuson

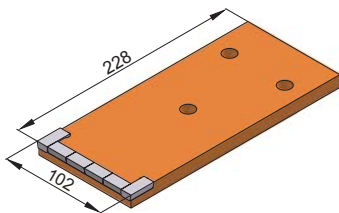
→ **BFS221**

→ BFS220x100x12

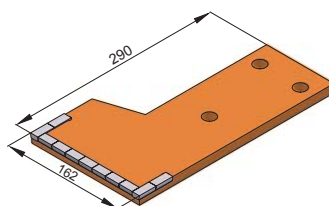
→ **BFS258**

→ BFS290x162x12/Re